

# Tasty Chips Electronics

## Integral

### User manual

© Tasty Chips Electronics 2022-2024

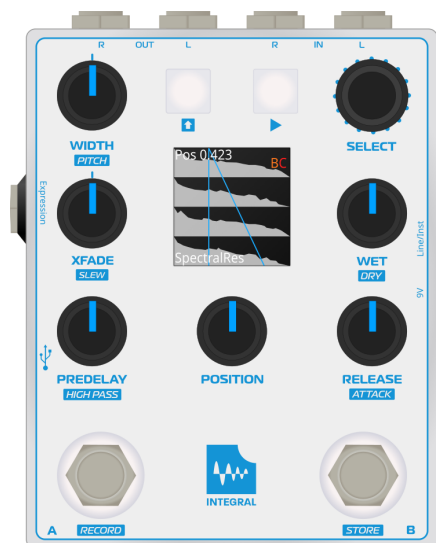

### Document version

Document version 3.2.1

Applicable firmware version: 3.2.x

# Introduction

Integral is designed to offer high quality true-stereo convolution reverb in a compact package, for use with guitar or line-level sources like synths or even mixers.

Aside from being able to accurately recreate acoustic spaces, Integral has ample potential for creative sound design by allowing the user to filter, stretch and manipulate the impulses, and load external impulses from a USB stick. Impulses can be directly recorded to the unit and instantly audited, and an expression pedal input is provided to give hands free control over parameters.

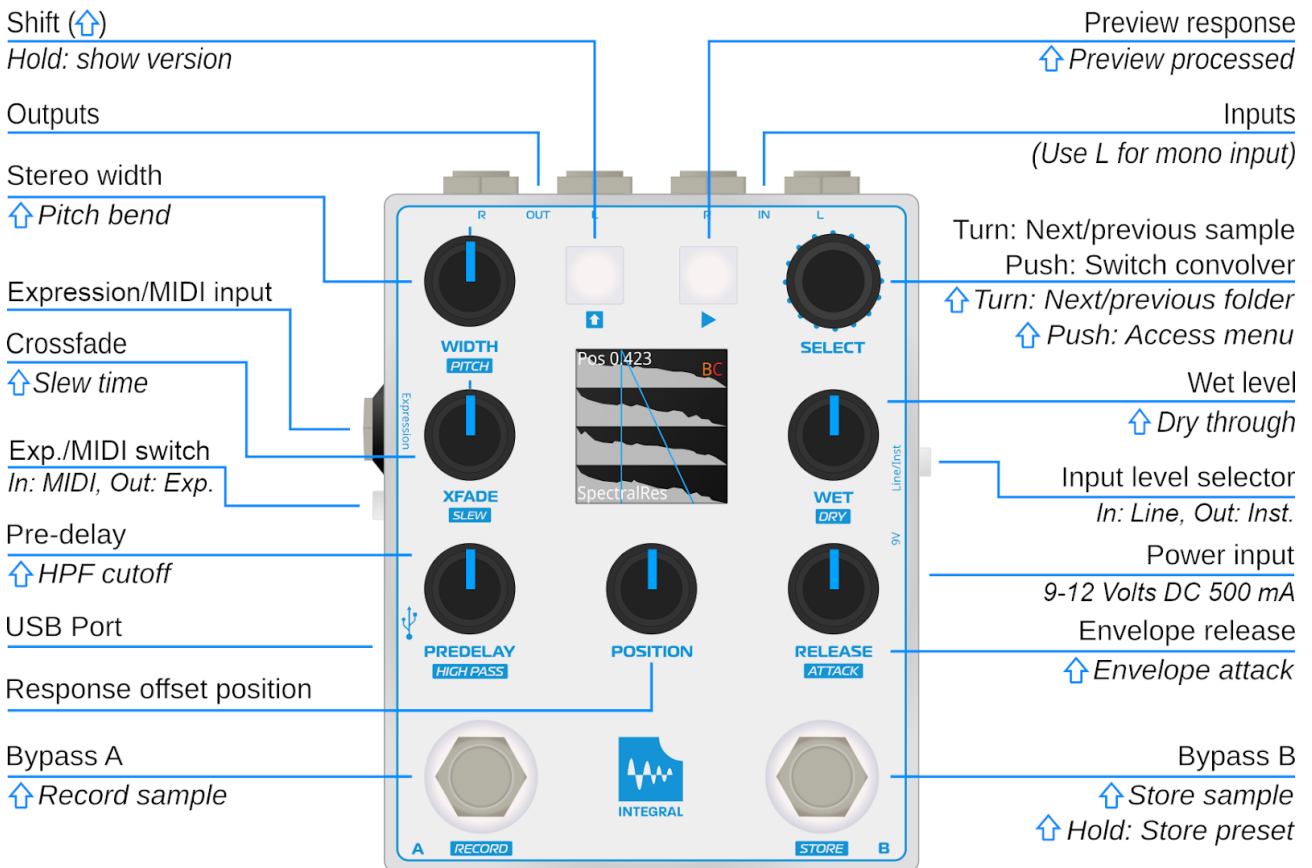

# Table of contents

<a href="#">Introduction</a>	2.
<a href="#">Warranty</a>	4.
<a href="#">What's in the box</a>	4.
<a href="#">Getting started</a>	5.
<a href="#">Signal path</a>	6.
<a href="#">Understanding the display</a>	7.
<a href="#">Using the envelope controls</a>	8.
<a href="#">Using the remaining parameters</a>	8.
<a href="#">Shift functionality overview</a>	9.
<a href="#">Using the dual convolvers</a>	10.
<a href="#">Expression pedal</a>	10.
<a href="#">Choosing samples</a>	11.
<a href="#">Recording responses</a>	12.
<a href="#">Presets</a>	12.
<a href="#">System menu</a>	13.
<a href="#">MIDI</a>	15.
<a href="#">Firmware updates via USB</a>	16.
<a href="#">Firmware installation failsafe</a>	16.
<a href="#">Recommended hardware</a>	17.
<a href="#">Troubleshooting</a>	18.
<a href="#">Features</a>	18.
<a href="#">Credits</a>	19.
<a href="#">Contact</a>	19.

## Warranty

The Integral comes with a 1 (one) year warranty on factory defects. Warranty is effective from the date of shipping of the unit.

“Factory defects” covers:

- Broken parts (for instance: cracked screen, broken buttons, or knobs)
- Non-functional unit (“dead on arrival”)
- Semi-functional unit with serious defects (for instance: inability to access the USB stick, mute audio inputs or outputs).

In case of such defects, you can reach us at [info@tastychips.nl](mailto:info@tastychips.nl), and claim your unit to be repaired. We'll contact you with all the necessary information for return shipping and will refund all postage costs incurred. Please understand that shipping and repairs may take several weeks depending on the severity of the defect and your location in the world.

We'll first attempt to repair your unit. If, and only if, the unit is damaged beyond repair, we'll send a new unit.

NOTE: opening the unit and tampering will VOID WARRANTY.

## What's in the box

- Integral pedal
- Quick start guide
- Velcro pads
- Tastychips stickers

## Getting started

1. Connect the Integral to a 9 or 12 volt power supply that supplies at least 500 mA.

**Tip:** The Integral accepts both center negative and center positive DC power supplies.

2. Hook up audio output cables.
3. Press Play [▶] to test the output of the selected response.
4. Press Play [▶] again to stop the test.
5. Hook up the audio input. If you are using a mono input, use the L input.
6. To begin with a blank slate, make sure the Predelay is completely 0, Xfade is centered, and Wet is maximized. The Pos knob should be 0. The Attack setting should be 0, and Release should be maximized, enabling the full response to be used.
7. If used with a line level source or in an effects-loop, set the line/inst switch to line by pressing it *in* to prevent clipping.

**Note:** With the switch pressed *in* the Integral is set to *line* input, and with the switch sticking *out* it's set to *instrument* level input.

8. Press the A or B footswitch and enjoy the reverberated sound!
9. Turn the Select knob to the right to try the next response.

## Signal path

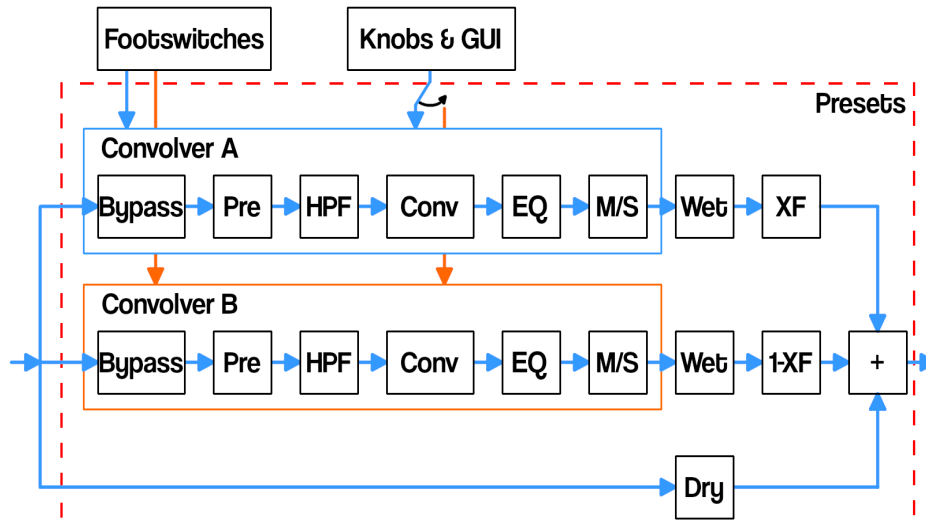

As you can see the two internal convolvers both have their own processing chain: PRE for predelay, a high-pass filter, 4-band parametric EQ and followed by a Mid-Side matrix (aka stereo width on the front panel).

The bypass footswitches switch the signal going into the convolvers, leaving the tails to fade out naturally when you switch them off. With a pair of quick taps you could apply the effect to just one phrase for example.

Predelay delays the signal going into the convolver, this has the dry signal appear more forward compared to the convolution product, allowing you to make small spaces sound bigger and create clarity in dense reverbs.

The high-pass filter is typically employed to keep bass and sub-bass from blowing up. Combining a bass-heavy input with a bass-heavy response sample often calls for such a feature. A parametric EQ is provided for further tone shaping.

Mid-Side is used to exaggerate or diminish stereo effects in the input signal. It may be used to turn it completely mono, or amplify the width. Even with mono input you can still widen the stereo image, if your response is stereo.

**Tip:** On the high end of its range the width pot may boost the apparent volume slightly, you might need to adjust the wet knob accordingly.

The convolution chain is followed by wet attenuation. Finally, the convolver outputs are crossfaded and summed with the dry signal.

**Note:** Only one convolver is controlled by the knobs and buttons at any one time.



## Understanding the display

After startup the Integral will show the main screen: most importantly sample waveforms and control values.

The display shows the response sample in a straightforward way, along with its name at the bottom, and an action message at the top. Such an action may be “WET -6.0DB”, “ATTACK 0.500s”, “CONVOLVER A”. So either value updates, or discrete actions.

The display shows either convolver A or convolver B. You can see a blue “A” or an orange “B” near the upper right corner of the screen. Either push the Select knob to toggle between the two, or press the corresponding footswitch to toggle which convolver is controlled by the knobs.

The display shows up to 4 sample channels. Everything you need for true stereo reverbs. From top to bottom, these are:

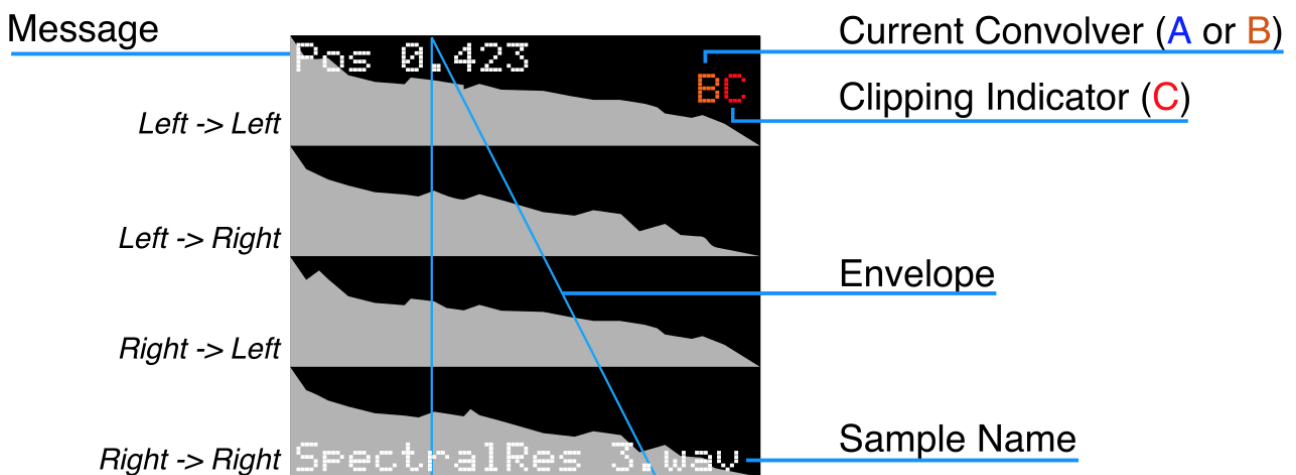

If a plain stereo sample is loaded instead of a 4 channel sample, only two channels are visible. Why these 4 channels? This is for the so-called stereo matrix. The left input can also influence the right output and vice versa.

The samples are displayed at full length, and the amplitude is logarithmic so that details in the reverb tail may be better visible. Between the channels the difference in amplitude is exaggerated. This quickly tells you if the response is off-center.

The overlaid blue lines show the AR (Attack-Release) envelope.

Near the upper-right corner of the screen you may see a yellow or red “C” appear from time to time. This indicates the total wet signal is clipping or almost clipping. The Integral then automatically limits the gain, displaying the “C” in yellow. You may want to attenuate the wet signal, or switch between the line and instrument input modes, depending on the situation.

On the bottom of the display the current sample filename is displayed.



## Using the envelope controls

An attack-release type envelope allows attenuation of parts of the response sample. The start position (time) of this envelope can be set using the “Pos” knob. Setting the position will completely skip over any sample data that comes before this position in the response sample. The combination of these three knobs allows you to precisely focus on any specific part of the response, for instance the tail, or only the early reflections. The position control has a precision of 1024 steps. The Release and Attack [ $\hat{+}$  + Release] settings have the same resolution, and using their exponential control curve you can achieve very short attacks or releases and still accurately control them. The attack and release time are displayed on screen down to milliseconds.

The applied envelope attenuates the response in places. To have no attenuation at all (to actually disable the envelope’s function): turn Attack and Pos to 0, and turn Release to its maximum. Note that the Integral uses normalization after applying the envelope. This will preserve signal power, however it can also significantly boost the wet signal. You can compensate by turning down the Wet knob.

Note that when attack is non-zero, you may experience a gap in the audio. Each time the envelope is changed the convolver recomputes and restarts. Since a longer attack will result in low volume, you may hear short gaps in the output as you continue to change the envelope. This can be compensated by increasing Slew. See the section [“Using the remaining parameters”](#) for more information on that.

## Using the remaining parameters

**Predelay:** 0-2.0s in with an exponential control curve. Using this often influences the perception of the size of a reverberating space. For instance, you can make a short reverb of a small room appear bigger by turning this up a little. Adjustment of this control causes the convolver to recompute its data. This may take a short while. Also note that the convolver restarts after adjustment and it starts with playing back the delay.

**Highpass filter cutoff** [ $\hat{+}$  + Predelay]: To keep the convolution from blowing up you can cut away some low frequencies from the audio input. The high-pass is a 12dB per octave filter with a full range of 20 to 20000 hertz, and an exponential sweep gives fine adjustment in the lower frequencies.

**Stereo width:** This is a Mid-Side matrix control that either turns the input into mono (turn it down to 0), or exaggerates the stereo effect (turn it completely right). The center keeps the stereo input audio signal exactly as it is.

**Pitch** [ $\hat{+}$  + Stereo width]: Hold down Shift and turn the Stereo width knob to pitch bend just the impulse response. This does not change the pitch of the convolved signal itself, but changes the timing and formant, and allows you to tune resonator-style impulses. Completely left means -2 octaves, completely right means +2 octaves. Center keeps the response the same pitch.

**Xfade:** Crossfade between convolver A (left on the knob) convolver B (right on the knob). Please read the section [“Using the dual convolvers”](#) for more information.

**Slew time** [ $\hat{+}$  + Xfade]: recomputation slew time controls the crossfading time between newly computed response and old response. Such a cross fade occurs when a new impulse response is offered to the convolver. For instance when a new response is selected by turning the select knob, or when the envelope or envelope position is changed. A short slew time sounds more choppy, but you’ll hear the new response faster. A larger slew is especially useful with longer envelope attack.

## Shift functionality overview

<b>Knob/Button:</b>	<b>Normal function:</b>	<b>Shift function [⇧]:</b>
Width Knob	Stereo width	Impulse pitch
Xfade Knob	Convolver crossfade	Slew Time
Predelay Knob	Predelay time	High pass filter
Release Knob	Release time	Attack time
Wet Knob	Wet level	Dry level
Encoder Push	Swap convolver (Hold to select presets)	System menu
Encoder Turn	Prev/Next impulse/preset	Prev/Next folder
Play Button	Preview impulse	Preview impulse with processing (Width, pitch & envelope)
Footswitch A	Toggle Convolver A	Record (Press again to stop recording)
Footswitch B	Toggle Convolver B	Store (Hold to save preset)

## Using the dual convolvers

The Integral runs two internal convolvers simultaneously. There's one in the foreground, which is directly controlled by the knobs, and there's one in the background. The background convolver is not currently controlled by the knobs, but holds another response sample and it has its own (static) settings such as another envelope, filter settings and pitch, but it can be controlled via expression pedal if you choose. For this see the "[Expression pedal](#)" chapter.

The Xfade (crossfade) knob creates a mix between the two convolvers:

1. Set up your foreground convolver using the "select knob" to choose a response, and turn the other knobs (except crossfade) until you have a satisfying convolution.
2. Now press "select". This switches the foreground convolver into the background. The display will let you know: "CONVOLVER B"
3. Turn Xfade to the left a bit to hear the convolver **A**, and to the right for convolver **B**.
4. Select a nice new response sample for convolver **B** by turning "select", and set the parameter knobs to your liking.
5. Wiggle Xfade. If you're using reverb responses, you are now traveling between spaces!

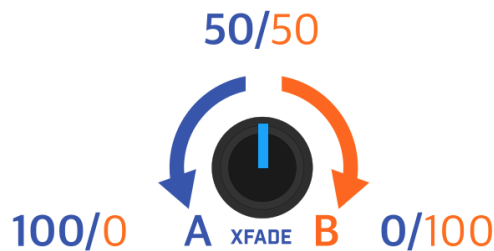

**Tip:** You can toggle between the two encoders by pressing the Select encoder, but you can also simply press the **A** or **B** footswitch to control the corresponding convolver.

## Expression pedal

The Integral accepts a standard expression pedal to provide hands-free control over a chosen parameter. You need a TRS expression pedal with a linear sweep and a resistance of at least 10 kOhms. Please read the "[System menu](#)" chapter for more information.

The expression socket on Integrals produced from 2025 onward is dual purpose, with the switch next to it selecting its function. To use an expression pedal, put the switch in its outward position. Pressing it in allows you to hook it up to MIDI, for more information see the chapter "[MIDI](#)".

## Choosing samples

The Integral offers a file chooser to help you browse through vast libraries of samples and settings. All samples and settings are present in one big list, through which you can quickly scroll back and forth. No diving into directories, no choosing of data types to load. Turn the Select knob to enter the file chooser screen. Turn a bit more to start choosing another sample.

The Integral's USB port allows you to use a USB stick or Micro SD card (via a USB-SD adapter). It also comes pre-loaded and with loads of original responses recorded by the Tasty Chips Team and others, there are over 60 samples in the Integral's internal flash memory.

Once a USB drive/SD card is inserted the Integral will automatically register all the `.wav` files in the root directory, and in the folders in the root directory. Note that it does not scan any deeper than 1 level! This means that folders in folders are skipped. It slurps up all the sample file names and compiles them into a big list you can scroll through. It may take a few seconds before the Integral has correctly mounted and processed all the files. It accepts USB sticks formatted in FAT, ExFat, and Linux Ext filesystems.

If there are a lot of responses on the USB drive/SD card, you may want to hold down Shift [⇧] when turning the Select knob. This jumps from folder to folder instead of from file to file. While browsing, the ECR shows the current folder at the top of the screen. This also helps you to distinguish if samples are in internal memory or are external.

Browsing automatically loads and activates new samples. When Play [▶] is active, you can easily preview sounds this way. In the top left corner it also shows A or B to tell the user which convolver's sample and/or preset we're loading.

When you have selected a sample you like, return to the main screen by pushing Select, or wait for 4 seconds if you have the AUTO EXIT feature enabled in the global. For this read the "[System menu](#)" chapter. If instead you want to cancel the sample selection and go back to the previously selected impulse, press Shift [⇧] + select.

All the way up top we see tabs for selecting impulse responses and presets. Hold down the encoder for a second to switch between the two. Please read the section "[Presets](#)" for more information on that.

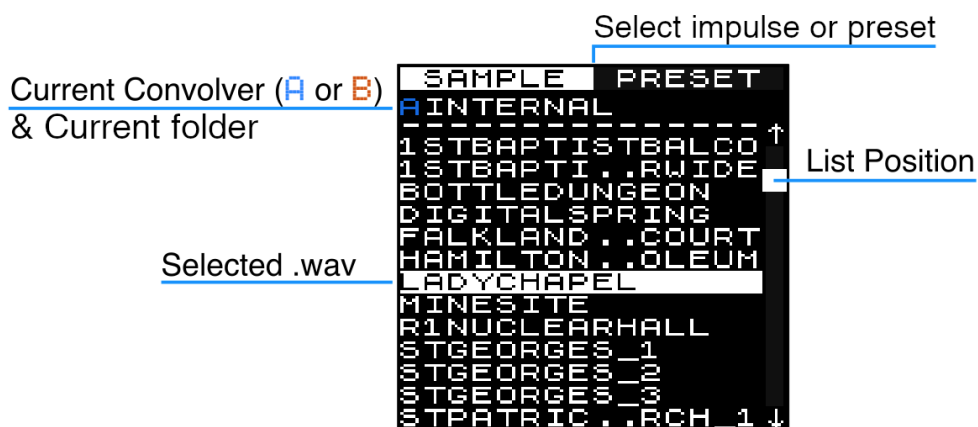

**Note:** The Integral will accept impulses of all commonly used samplerates, however it's advised to use the Integral's native samplerate of 48k, as this will load the quickest.

## Recording responses

Press Shift [⇧] and the left footswitch, this starts the recording process. The convolution engine will be disabled while recording and only dry output is heard. The recording stops when the left footswitch is pressed again, or when it has recorded for 20 seconds. You can now use the recording as if it were a response, apply the envelope, position, and modulation. Madness will ensue.

**Note:** From firmware 3.0.0 onwards you can select the record mode in the Global Settings menu: Aside from the default Shift [⇧] + A footswitch mode, you can opt to double tap the A footswitch to start the recording.

When a USB stick is inserted, you can store the recording by pressing Shift [⇧] and the right footswitch, the Integral will prompt you to name the recorded file, by default it will be assigned a filename audio\_XXXX.wav, you can change this or just keep the name. Hold the select encoder down for a second to save it, if no storage medium is present the right LED will pulse two times to indicate so.

**WARNING:** DO NOT POWER OFF OR REMOVE STORAGE MEDIUM WHEN STORING RECORDING OR PRESET. PLEASE WAIT A FEW SECONDS BEFORE DOING SO. IF YOU DO NOT, DATA LOSS MAY OCCUR.

## Presets

You can store the knob settings, active impulse responses, equalizer and settings in a preset. Just hold Shift [⇧] and the right footswitch for one second. This will prompt you to name the preset, by default it will be named preset\_XXXX.wav, you can change this or just keep the name. Hold the select encoder down for a second to save it, if no storage medium is present the right LED will pulse two times to indicate so.

When a preset is saved, hold down the select encoder for a second while in the file chooser menu to switch to selecting presets, rotate the encoder as usual to scroll through the list of presets, and press it to select one. It will now load the settings to both the A or B convolver, as well as the preset menu and EQ settings.



**Tip:** When presets are stored on the USB stick, they can be easily edited on your computer, just open the .prst files in an ordinary plain text editor.

**Note:** presets are saved to USB if available. Every time you plug in a USB stick the Integral will look for presets and load the last saved one, if found.

# System menu

Enter the main system menu by holding down Shift [⇧] and pressing Select. Here you'll find the following subsections:

- GLOBAL SETTINGS: General settings which control the overall behavior of the Integral. These are stored when the global settings menu is exited, and recalled when the Integral boots up.

- PRESET SETTINGS: Settings specific to the current preset. These are stored when a preset is saved, keep in mind they are overwritten when a different preset is loaded, or the unit is rebooted without saving.

- EQUALIZER A/B: Opens the parametric equalizer for either convolver A or B. These settings are also stored along with the preset.

- REVERSE IR A/B: Reverses it impulse response for either convolver A or B. Again these settings are stored along with the preset.

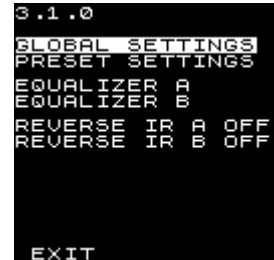

## Global settings

- DIRECT SHIFT: This switches between press-and-hold or toggle functionality for the shift button. Often beneficial, because it frees up one more hand for knob twisting.

- AUTO EXIT: Leave the file chooser after 4 seconds. Can speed up your workflow. When this is OFF you will need to press the Select knob to leave the file chooser.

- PICKUPS: Locks the knobs when they are not in the corresponding position for the preset, and when switching between main and shift functionality. A lock icon will be displayed along with the current setting of the parameter, turn to this point to unlock the knob. This can be very useful for live performance when you don't want sudden jumps in your parameters after loading a preset or switching between the convolvers.

- REC MODE: You can select the record mode: Aside from the default Shift [⇧] + A footswitch mode, you can opt to double tap the A footswitch to start the recording.

- SCREENSAVER: Screensaver time: 0 seconds, 30 seconds, 2 minutes, or 5 minutes. After this time the display will turn to black until a button or knob is touched.

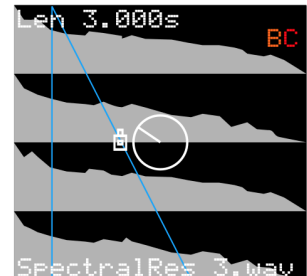

- WAVE CONTRAST: Adjusts the contrast of the impulse waveform visualization to compensate for lighting conditions and display variance.

- USB IR FIRST: The file chooser will show the external impulses first if a USB stick is inserted, in case you are not that interested in the stock IR's.

- MIDI CHANNEL: You can set the Integral to respond only to midi messages from a set channel, or all channels. See the section "[MIDI](#)" for more information.

- MIDI MONITOR: A simple utility to check which midi messages are being received.

- SAVE AND EXIT: The global settings are stored when the menu is exited.

## Preset settings

- DRY MODE: The Integral has several dry modes:

MIX: Regular dry and wet level knobs, in bypass the dry signal will be fed through normally.

DIRECT: Extra low latency and noise, but you give up the dry level control.

KILL: Eliminate the dry signal both when the effect is active and in bypass, this is especially useful when hooking the Integral up to a mixer as a send/return effect.

- GATE THRESH: The Integral now has a simple noise gate for the signals going in to the convolvers, lower settings can cut the ringing on particularly resonant IR's, usually having the threshold around -75 is enough.

- EXP MAP: Assigns the expression pedal to either the A or B convolver, or both.

- EXP CONTROL: Assigns the expression pedal to a parameter of the convolvers selected in EXP MAP.

POS: Position

WET: Wet level

XFD: Xfade

PIT: Pitch

Tip: For global parameters like XFD the EXP MAP setting is moot, as they control both convolvers. And when EXP MAP is set to NONE, the expression pedal will be unassigned completely.

- MIDI: A preset can be assigned a midi program change, control change or note-on, and will be recalled when this midi message is received. For more information see the chapter "MIDI".

- RENAME PRESET: You can rename the current preset, this replaces the current preset. To make a copy, simply save the preset again, changing the name.

- DELETE PRESET: Delete the current preset, take note this cannot be undone.

**Note:** The three settings mentioned above are only available when a pre

```
PRESET SETTINGS
>PRESET_NAME
DRY MODE MIX
GATE THRESH OFF
EXP MAP NONE
EXP CONTROL POS
MIDI NOTE C 3
RENAME PRESET
DELETE PRESET

EXIT
```

- EXIT: Exit the menu.

# MIDI

From firmware version 3.1.0 on Integral now features MIDI capability over USB to load presets. Integral acts as a midi-host, allowing connected devices like midi controllers, multi-fx units or loop-switchers to take control of the Integral. A host-to-host adapter can be used to connect the Integral to a computer.

Presets can be assigned a program change, control change or note-on. The latter two can even set the convolver bypass state based on their velocity/value:

- 0-123: No change.
- 124: Both convolvers off.
- 125: Convolver **A** on.
- 126: Convolver **B** on.
- 127: Both convolvers on.

The midi message corresponding to a certain preset can be set in the preset menu, if this setting is already in use by another preset, the text will turn blue and you will be asked to confirm if you want to overwrite.

**Tip:** If you turn the encoder while holding shift [⇧], the setting will jump in steps of the process.



The MIDI channel can be set in the Global Menu, where you will also find a simple MIDI-monitor, where you can see the status of the connection and the last four MIDI messages received.

Integrals produced from 2025 onward now support hardware MIDI over the TRS control jack socket on the left side of the pedal. The switch next to the socket selects its function: MIDI when it's pressed in, or an expression pedal when the switch is in the outward position.

**Note:** Integral is compatible with the MIDI standard Type-A TRS connection, see <https://minimidi.world/> for more information on different TRS MIDI implementations.

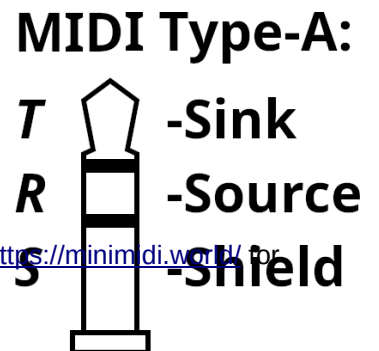



## Firmware updates via USB

1. Download the firmware zip file from our site <https://www.tastychips.nl/integral-support-page/> Make sure this is the correct firmware for your hardware! The file will be named "INTEGRAL\_fw\_x.y.z.zip" or "INTEGRAL\_fw\_x.y.z.tce", depending on the firmware revision.
2. Copy the file to the root of the USB stick. Do not unzip or rename the file.
3. Safely eject the stick from your PC, and insert it into your Integral's USB port. Wait a few seconds..
4. The Integral will now enter its update screen, waiting for you to press Select. If you don't press it it, will return to the main screen and resume normal operation after about 20 seconds.
5. The Integral will install and automatically restart. This shouldn't take more than 2 seconds.

**Note:** the Integral will remove the zip file from the stick, to not get stuck in a loop.



## Firmware installation failsafe

By powering off during USB firmware update (even if this only lasts less than a second), it could be that the firmware becomes corrupted. In this case the firmware employs a failsafe mechanism where it tries to first start up the old firmware, and if that's also corrupted, it will try and find an unzipped firmware on your USB stick. Although we've never encountered such a situation, the failsafe mechanism has been tested. Should you encounter this you can recognize it by the screen staying black, no matter which knobs you turn or which buttons you push, and this persists after a cold restart (10 seconds power off).

1. Download the firmware zip file from our site <https://www.tastychips.nl/integral-support-page/> Make sure this is the correct firmware for your hardware! The file will be named "INTEGRAL\_fw\_x.y.z.zip" or "INTEGRAL\_fw\_x.y.z.tce", depending on the firmware revision.
2. Unzip it and make sure all files are present in the root of your USB stick.
3. Also make sure the original firmware zip is still on the stick. The ECR will use it to try and install the firmware again.
4. While the ECR is powered, insert the stick. It should now run the firmware from the USB stick.
5. Wait until you see the update screen and follow the instructions.

# Recommended Hardware

Integral is designed to work with a wide variety of power supplies and USB drives, however the exact hardware can sometimes give unexpected results. We have compiled a list of devices that have been tested and verified to work with Integral, if you have good results with other hardware, feel free to email us at [info@tastychips.nl](mailto:info@tastychips.nl) to have them added to the list.

For all USB Sticks, they have to be formatted in FAT, ExFat, and Linux Ext filesystems.

## USB Drives:

- Kingston DataTraveler Micro
- Kingston DataTraveler SE9
- SanDisk Ultra Fit

## Power Supplies:

- Meanwell GST18A09
- Boss PSA-230S
- Truetone TRT-02 1 SPOT
- Truetone 1 SPOT Pro CS7

# Troubleshooting

The Integral receives a full functional test when leaving the factory. The firmware has been meticulously tested for stability over a 24 hour period with all kinds of inputs and control changes. However, in the rare case of a crash or hang, or any other strange glitch, please contact us at [info@tastychips.nl](mailto:info@tastychips.nl).

Things to keep in mind:

- Always turn the unit off for at least 10 seconds before powering back up again. Otherwise it might start up with unresponsive controls.
- Do not power off the Integral or remove the USB drive when storing a recording or preset. If you don't, you run the risk of losing data.
- The Integral can be quickly reset without powering down. Hold down the Play [▶] button, the **A**, and **B** footswitch for 4 seconds. The screen will black out for a while, but the main screen will quickly re-appear.

# Features

- Long true-stereo natural reverbs (23s max).
- Dual simultaneous reverbs (foreground and background), with their own presets.
- Multi-channel display with envelope and parameter-value overlays, and a clipping indicator.
- Mono or stereo in- and output, accepts line or instrument level.
- Switchable analog dry through.
- Attack-Release Envelope.
- Cross fade knob (cross fades between the foreground and background response)
- Predelay up to 2 seconds.
- Rotary encoder to quickly select responses (internal impulses and the ones present on USB/SD).
- High-pass (12 dB/oct) filter with adjustable cutoff.
- Real-time pitch adjustment of response (-2 to +2 octaves).
- Record and use responses from USB.
- Audition feature to quickly evaluate responses.
- 48 kHz stereo input.
- 1.3" true color 128×128 pixel LCD.
- Saves samples as 32 bit float stereo WAV files.
- 10 bit resolution and ~50 Hz refresh on potentiometer action.
- 9 or 12v powered, 500mA minimum.

## Credits

The internal samples are creative commons (CC BY-SA 3.0) <https://creativecommons.org/licenses/by-sa/3.0/> licensed responses that were available from `openairlib.net`. They're all resampled to the Integral's native sample rate of 48 kHz.

Falkland Palace Bottle Dungeon:	Dr. Damian T. Murphy
Falkland Palace Royal Tennis Court:	Dr. Damian T. Murphy
Hamilton Mausoleum:	Dr. Damian T. Murphy
R1 Nuclear Reactor Hall: Audiolab, University of York,	Dr. Damian T. Murphy
Terry's Factory Warehouse: Audiolab, University of York,	Dr. Damian T. Murphy
York minster: Audiolab, University of York,	Damian T. Murphy
Lady Chapel, St Albans Cathedral: Audiolab, University of York,	Marcin Gorzel Gavin Kearney Aglaia Foteinou Sorrel Hoare Simon Shelley
1 <sup>st</sup> Baptist Church,	Adam Townsell Xuan Liu
Mine Site2 _1way bformat ,	Andrew Chadwick Simon Shelley
St Georges (close) (far) (medium)	Adam Townsell
St Patrick Church (1), (2), (3): Audiolab, University of York,	Aglaia Foteinou Dr. Damian T. Murphy
Middle tunnel:	? Author unknown, Please contact us!
Micro Small/Large/Gate/Reverse:	Joeri Braams
Tapedelay Long/Short Dark/Short Thin:	Joeri Braams
Everything else: Copyright © Tasty Chips Electronics 2018-2023	

## Contact

info@tastychips.nl